

440.2385600 (tech)

2385.60

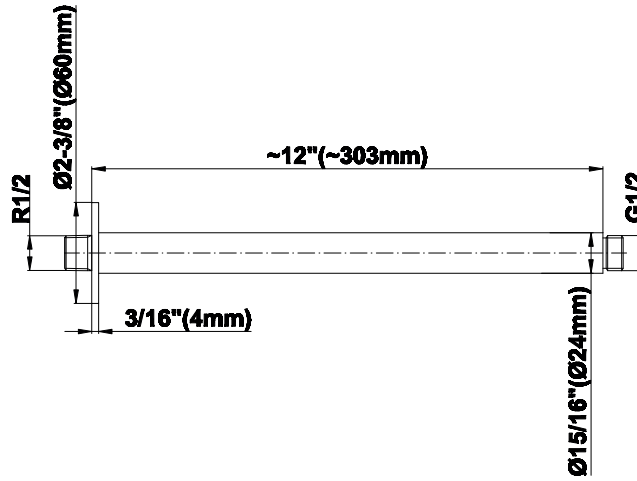

GRAFF[®]
CUTTING EDGE DESIGN

