

460.21029 (tech)

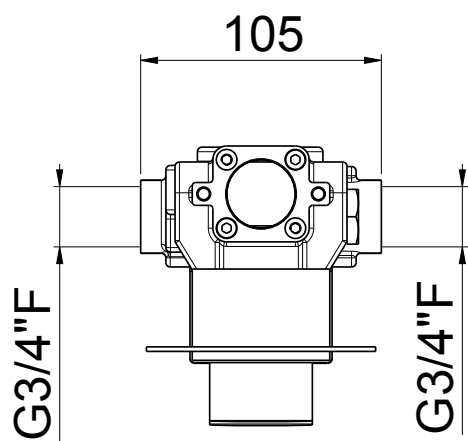

460.21029 (tech)

Met montageset in inox
Avec boîtier d'encastrement en Inox

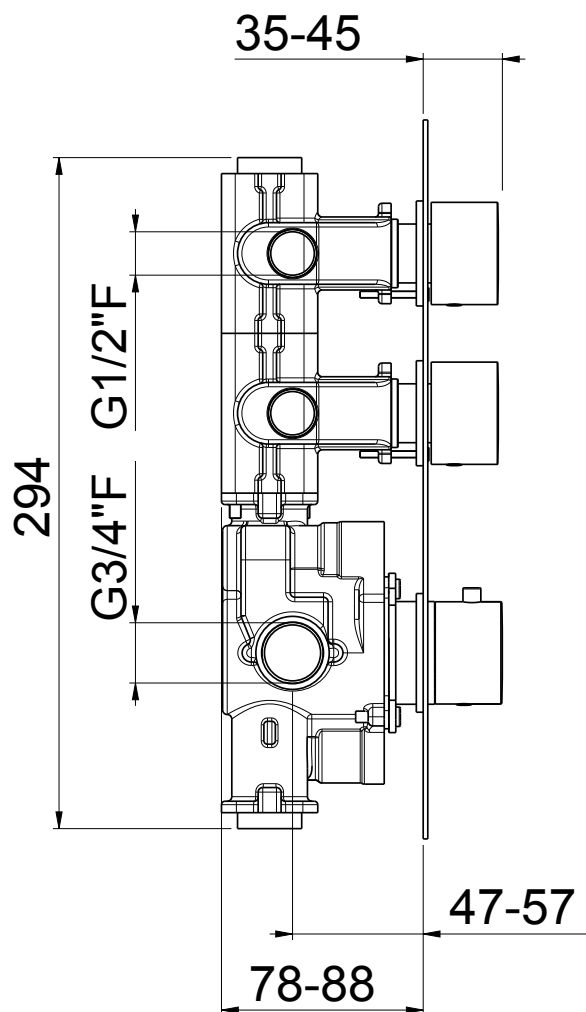
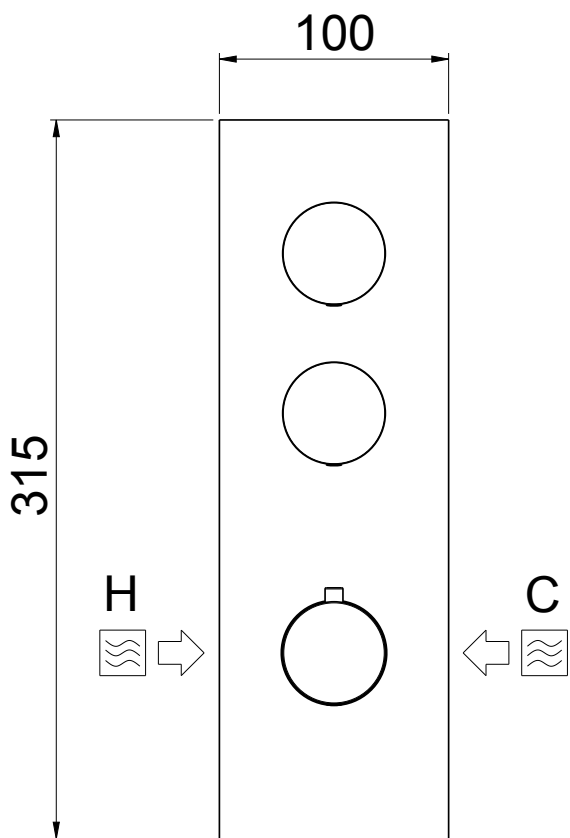