

460.21039 (tech)

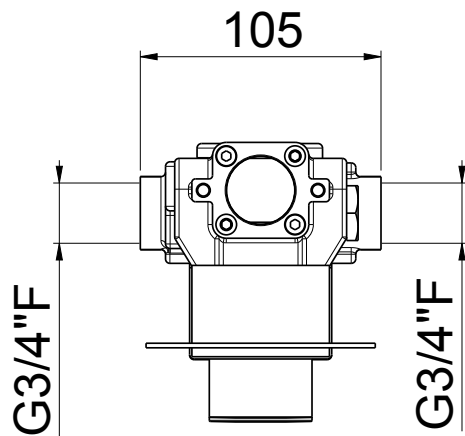

460.21039 (tech)

Met montageset in inox
Avec boîtier d'encastrement en Inox

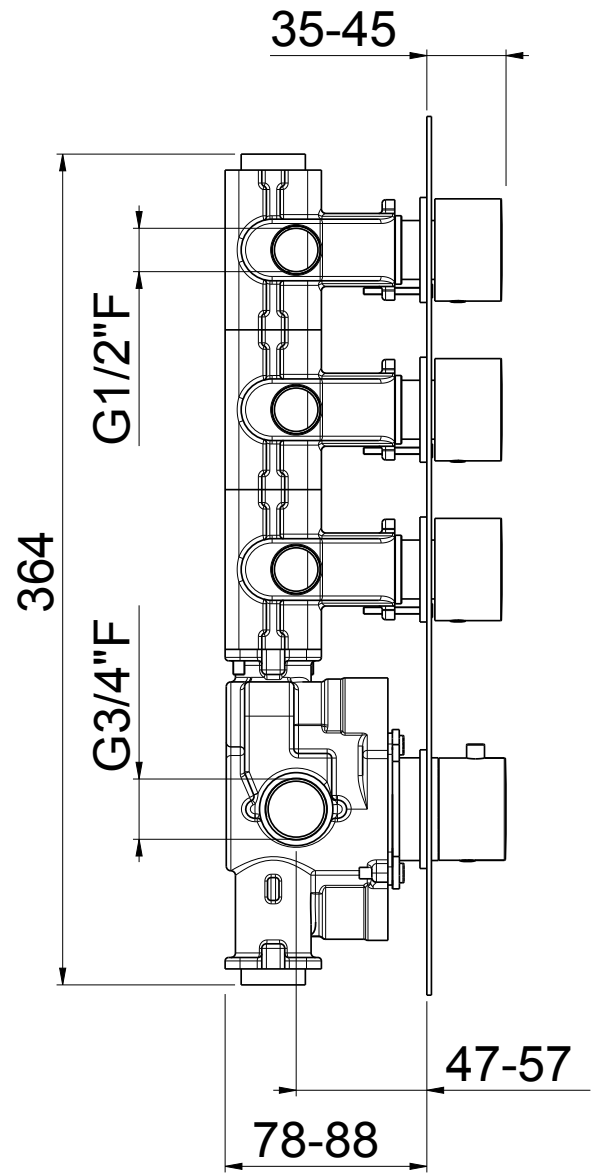
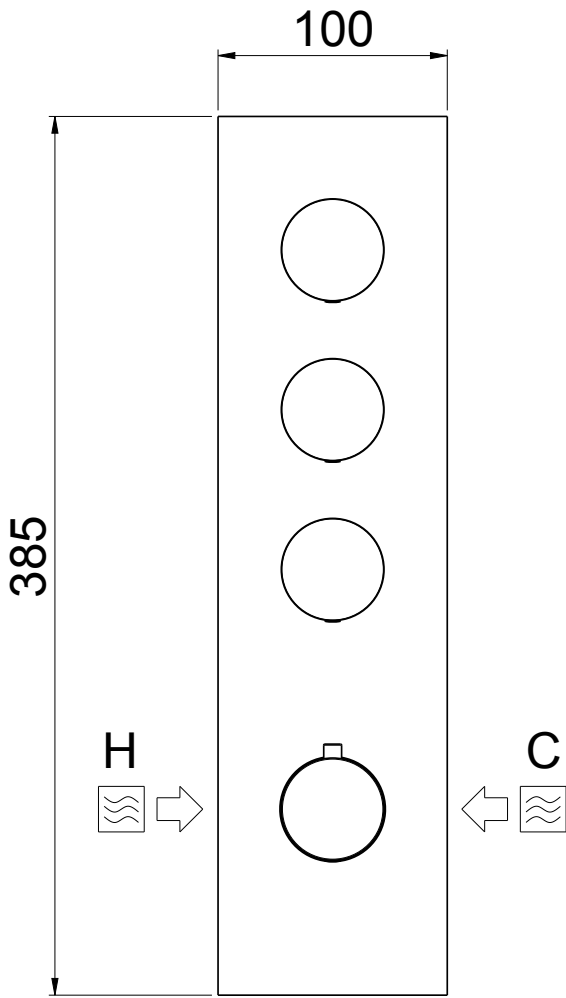