

460.21059 (tech)

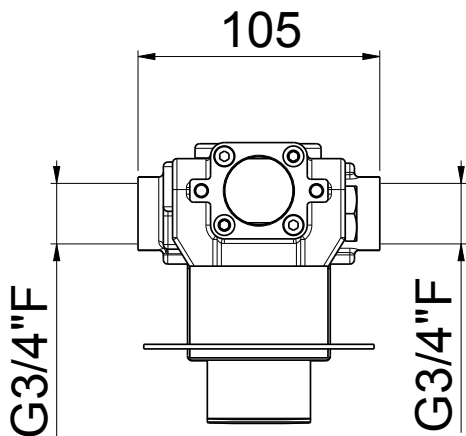

460.21059 (tech)

Met montageset in inox
Avec boîtier d'encastrement en Inox

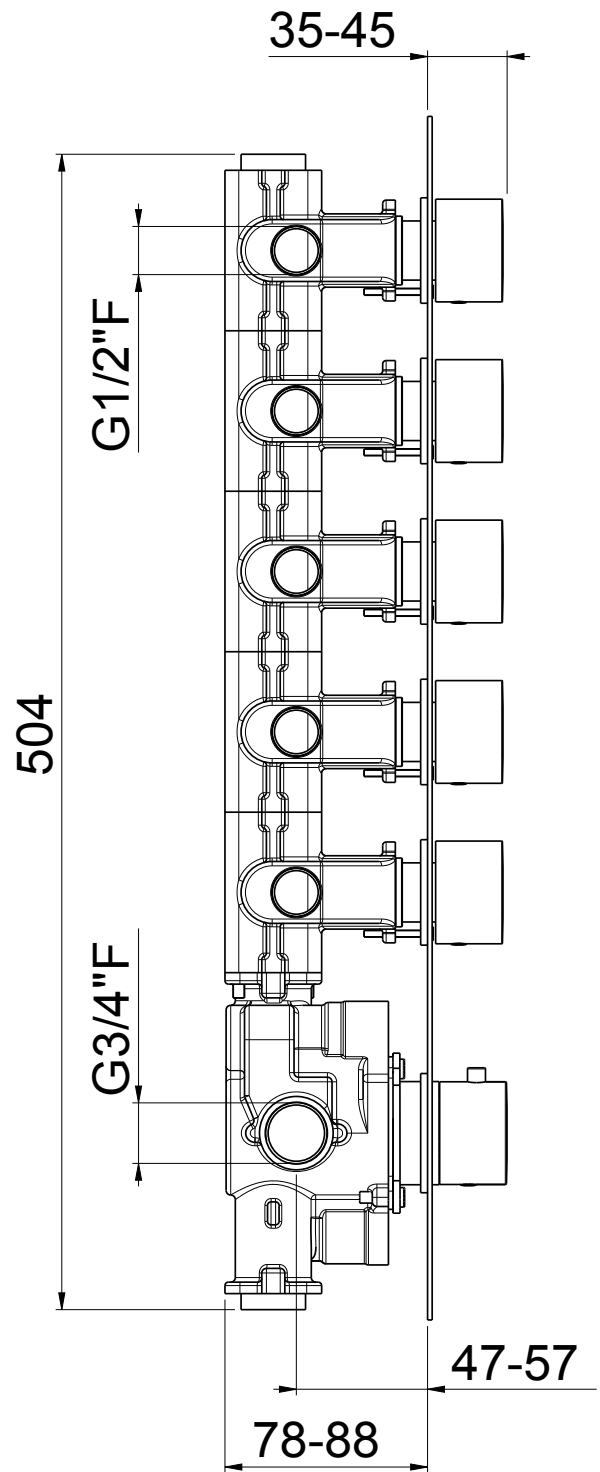
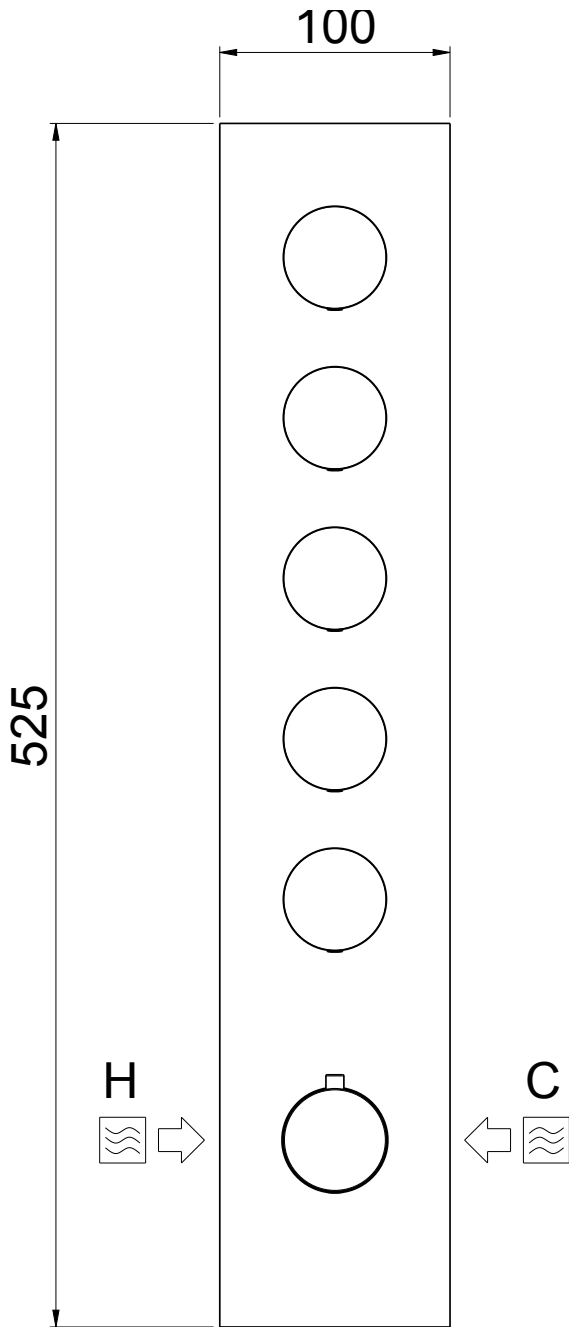